

Lifetime
Warranty

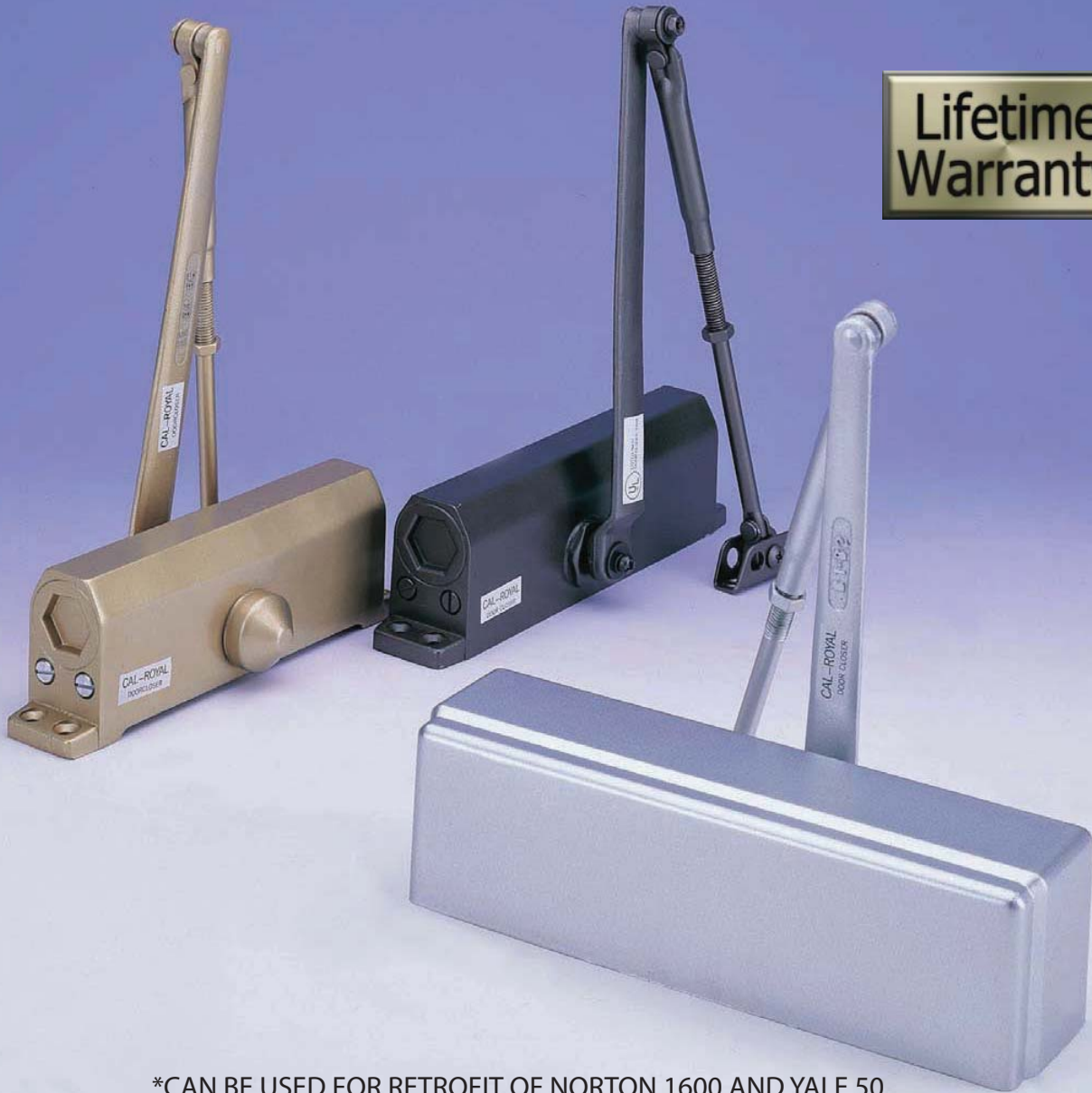

*CAN BE USED FOR RETROFIT OF NORTON 1600 AND YALE 50

- **MEETS AND EXCEEDS ANSI STANDARD 156.4 GRADE 1**
- **UNIVERSAL HOLE PATTERN OFFERING VERSATILITY AND PRECISION ENGINEERING FOR NEW AND RETROFIT MARKET**
- **MULTI SIZE AND ADJUSTABLE COMMERCIAL DOOR CLOSER SIZES 1 THRU 4 AND 3 THRU 6 MEETING BARRIER FREE APPLICATIONS**
- **HYDRAULIC DOOR CLOSER WITH STANDARD BACK CHECK**
- **FULL PLASTIC COVER IS STANDARD FEATURE**
- **OPTIONAL ADJUSTABLE DELAYED ACTION FOR HANDICAPPED OR ELDERLY**

300 Series Door Closer

**Full Cover Multi-size
Full Feature Closer
ANSI 156.4 Grade 1
UL Listed, Conforms to Standards
UL10C and UBC7-2-1997
LIFETIME WARRANTY**

300 Series Door Closer



FEATURES

- Factory tested to meet or exceed ANSI Standard 156.4 Grade 1
- 300 PBFCOV: Non-sized, fully adjustable 1 through 4, (Barrier Free ADA). Full cover. For 30-185 lbs door weight
- 300 PCOV: Non-sized, fully adjustable 3 through 6, (Barrier Free ADA). Full cover. For 85-260 lbs door weight
- Hydraulic door closer with standard adjustable backcheck valve
- Standard full plastic cover (2 5/8" W x 3" H x 10 1/8" L) COV/400
- Universal Mounting - standard size #4 Mounting Holes. (9-1/16")
- Finishes available: Alum, Dark Bronze (Duro), Gold and US3
- Dual valve, closing and latching speed controlled by two separate regulating valves
- Universal application, non handed, designed for all standard installations
- Reinforced type adjustable tube arm
- Rack and pinion operation contained in a high tensile precision cast with needle bearing aluminum housing for the highest quality
- High quality hydraulic fluid for high lubricity and constant lubrication
- The streamlined design permits installation on most commercial and residential applications without adaptors
- Power adjustment bracket on regular arms. (15% adjustment, $\pm 7 \frac{1}{2}\%$)
- Hold open arm optional (Part #301/302) for regular & parallel installations

UNIVERSAL APPLICATION

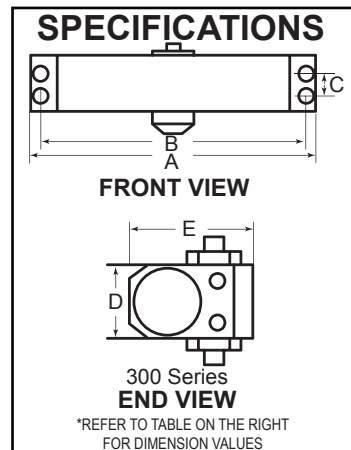
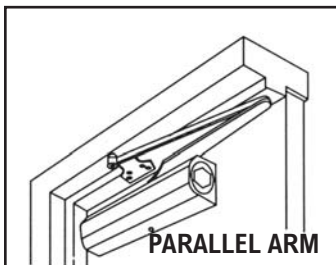
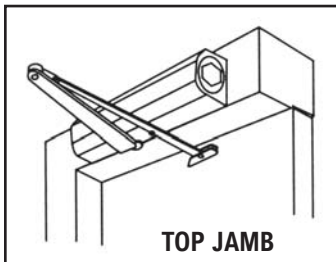
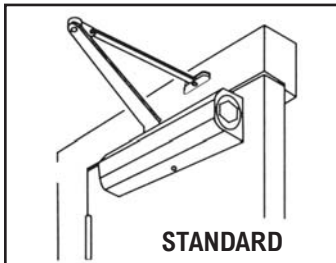

EXTERIOR (and VESTIBULE) DOOR WIDTH

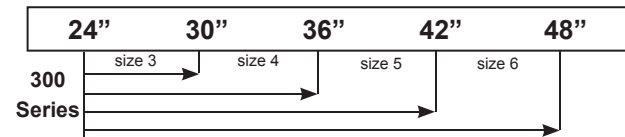

Minimum Door Width

INTERIOR DOOR WIDTH

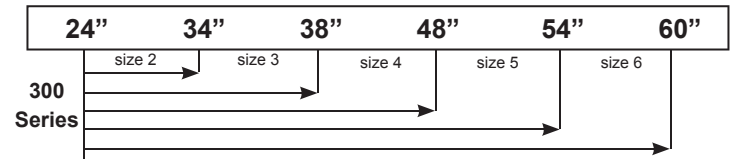

Minimum Door Width

Adjustable Size 1 thru 6

DIMENSION DESCRIPTION	300PBFCOV / 300PCOV
A. Length of Closer Body	9 3/4"
B. Horizontal Mounting Holes	9 1/16"
C. Vertical Mounting Holes	3/4"
D. Height of Closer Body	1 3/4"
E. Projection from Door	2 7/8"

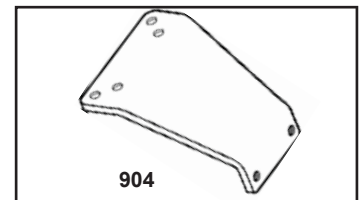
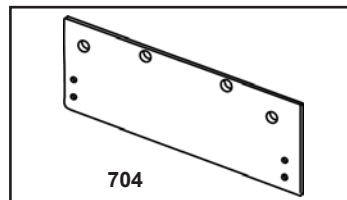
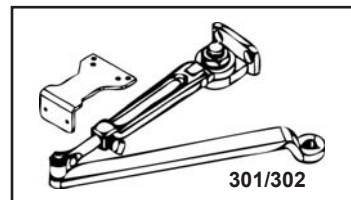

*** CAN BE USED FOR RETROFIT OF NORTON 1600 (Sizes 4, 5 or 6) Yale 50 (Sizes 4, 5 or 6)**

COMPARISON CHART 300 SERIES

CAL-ROYAL	DORMA	HAGER	LCN	NORTON	PARKER	SARGENT	YALE
300	640/7300/7400	5300	1070/1370	1600	900	1130	50

The data on this represents our judgment of which are most similar. Since no product is exactly alike the information has been obtained from trade sources, it is not guaranteed nor represented that any specific product exactly equals any other product.

UL Listed, Conforms to Standards UL10C and UBC-7-2-1997

